

Freezer 36 CO

Multi Compatible Tower CPU Cooler for Continuous Operation



General Specifications

Compatibility	Intel® LGA1851 LGA1700 AMD® AM5 AM4
PI NNPI	250 234
TIM	MX-6 (0.8g)
Warranty	6 Years
Operating Ambient Temperature	0-40°C
Dimensions	104 (L) x 126 (W) x 159 (H) mm
Weight	890g

Shipping Information - Freezer 36 CO

Box Dimension	190 (L) x 186 (W) x 117 (H) mm
Gross Weight	1230g
SKU	ACFRE00122A
EAN	4895213704137
UPC	840033401944

Heatsink Specifications

Heatpipes	4x 6 mm Ø, Copper
Finnstack	59x 0.4 mm, Aluminium

Fan Specifications

General	2x P12 PWM PST CO
Speed	200-1800 rpm, PWM Controlled (0 rpm below 5% PWM)
Bearing	Dual Ball Bearing
Current Voltage	0.10A 12VDC
Cable Length	200mm + 80mm Splitter Cable
Connector	4-Pin PWM-Connector + 4-Pin Plug

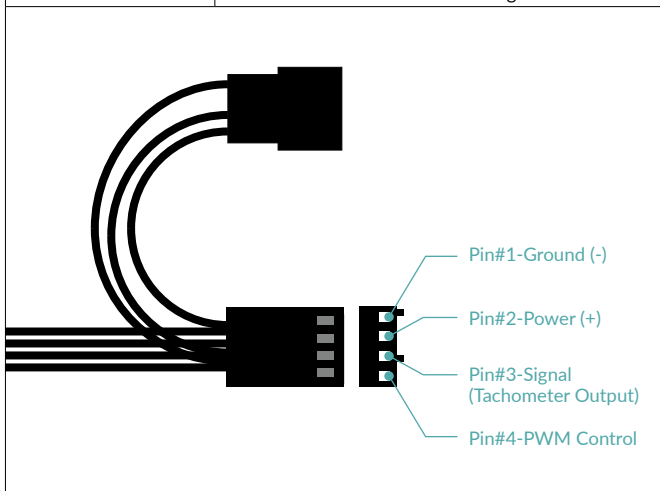

Freezer 36 CO

Multi Compatible Tower CPU Cooler for Continuous Operation

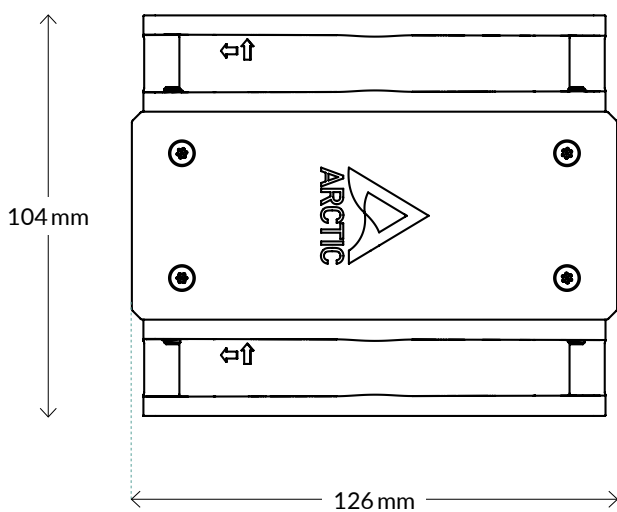
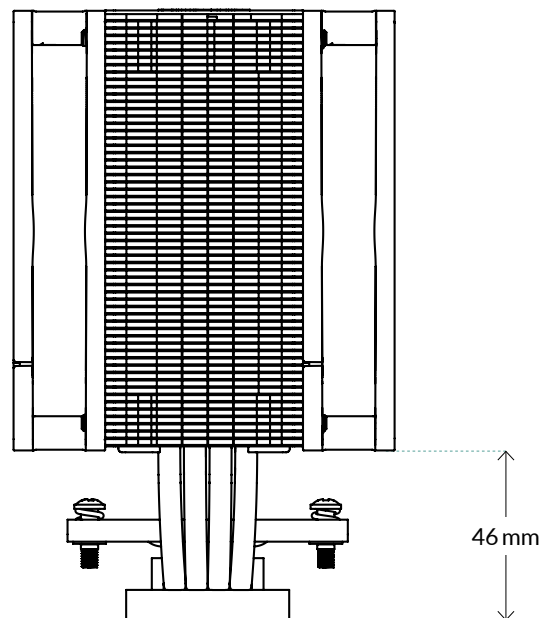
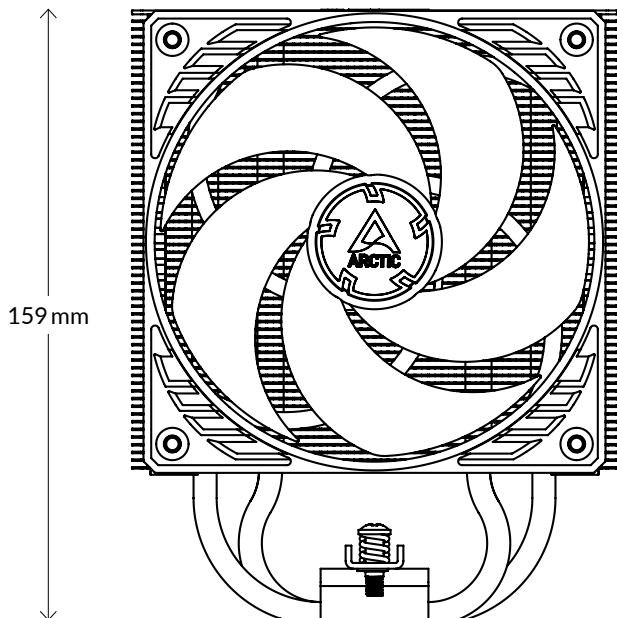

All materials are compatible with RoHS requirements.

MORE INFORMATION



MANUALS

