

STRONG



Google TV

SMART ANDROID TV™ BOX

LEAP-S3

4K

Ultra HD



Picture similar

Bedienungsanleitung
Manuel d'utilisation
Manuale utente
Manual del usuario
Manual do utilizador
Használati útmutató
Užívateľský manuál

Brugervejledning
Brukerveiledning
Gebruiksaanwijzing
Användarhandbok
Korisnički priručnik
Ръководство на потребителя
Посібник користувача

SERVICE CENTER

AT	  support_at@strong.tv 0820 400 150 (€ 0,12/Min. österr. Festnetz)	HU	  support_hu@strong.tv +36 1 445 26 10
BG	  support_bg@strong.tv +359 32 634451	IT	  support_it@strong.tv 199 404 032 Da rete fissa 24,8 cent. al min. 12,5 cent. scatto alla risposta Da rete mobile max 49 cent. al min. 15,6 cent. scatto allo risposta
CZ	  support_cz@strong.tv 844 44 44 90	NL	  support_nl@strong.tv
DE	  support_de@strong.tv 0180 501 49 91 (€ 0,14/Min. deutsches Festnetz) (€ 0,42/Min. max. Mobilfunknetze)	PL	  support_pl@strong.tv 801 702 017
DK	  support_dk@strong.tv	PT	  support_pt@strong.tv +351 2 100 06 125
ES	  support_es@strong.tv +34 91 119 61 76	SK	  support_sk@strong.tv 0850 15 05 50
FR	  support_fr@strong.tv	SL	  +386 1 828 08 58
HR	  +385 1 344 57 66	UA	  support_ua@strong.tv +380 (44) 238 61 50

Supplied by STRONG Austria
Represented by STRONG Ges.m.b.H.
Teinfaltstraße 8/4.Stock, A-1010 Vienna, Austria
Email: support_at@strong.tv

LICENSES

This product contains one or more programs protected under international and U.S. copyright laws as unpublished works. They are confidential and proprietary to **Dolby Laboratories**>. Their reproduction or disclosure, in whole or in part, or the production of derivative works therefrom without the express permission of Dolby Laboratories is prohibited. Copyright 2003-2009 by Dolby Laboratories. All rights reserved.

SIMPLIFIED EU DECLARATION OF CONFORMITY

Hereby, STRONG declares that the LEAP S3 is in compliance with Directive 2014/53/EU.

The full text of the EU declaration of conformity is available at the following internet address: <https://www.strong.tv/en/doc>. Subject to alterations. In consequence of continuous research and development technical specifications, design and appearance of products may change. Google, Google Play, YouTube, Android TV and other marks are trademarks of Google LLC. Wi-Fi is a registered trademark of Wi-Fi Alliance®. Skype is a trade mark of Skype and STRONG is not affiliated, sponsored, authorized or otherwise associated by/with the Skype group of companies. Manufactured under license from Dolby Laboratories. Dolby, Dolby Audio and the double-D symbol are trademarks of Dolby Laboratories. The terms HDMI, HDMI High-Definition Multimedia Interface, and the HDMI Logo are trademarks or registered trademarks of HDMI Licensing Administrator, Inc. All other product names are trademarks or registered trademarks of their respective owners.

© STRONG 2023. All rights reserved.

TABLE DES MATIÈRES

1. INTRODUCTION	4
1.1. Safety Instructions	4
Precautions	4
Operating Environment	4
WEEE Directive	5
1.2. Storage	5
Equipment Set-up	5
1.3. Package content	5
2. TV BOX PANELS	5
2.1 Front Panel	5
2.2 Side Panel	5
2.3 Rear Panel	6
2.4 Remote control	6
2.5 Installing the batteries	7
3. CONNECTION GUIDE	7
4. SETTING UP YOUR DEVICE	8
Step 1: Language	9
Step 2: Location Settings	9
Step 3: Set up with the Google Home App	9
Step 4: Wi-Fi	9
Step 5: Google Account	10
Step 6: Terms of Service & Privacy Policy	10
Step 7: Diagnostic Report Settings	10
Step 8: Meet your Google Assistant	10
Step 9: Choose your subscriptions	10
Step 10: Setup remote buttons	10
Step 11: Welcome to Google TV	11
5. SETTINGS	11
Display and sound	11
Network and Internet	11
Adding Accounts	12
Apps	12
Bluetooth Pairing	12
Remove a Bluetooth Device	12
Language Settings	12
About	12
Factory Reset	12
6. DOWNLOADING APPS	13
7. GOOGLE CAST	13
Cast from a Mobile Device	13
Cast from Google Chrome	13

8. GOOGLE ASSISTANT	13
Say it to Play it.	13
Movies & TV shows:	13
Control	13
Play music, news, or podcasts	13
Ask Google	14
9. SIMPLE TROUBLESHOOTING	14
10. TECHNICAL SPECIFICATIONS	15

1. INTRODUCTION

Thank you for choosing the 4K Ultra HD Google TV Box supplied by STRONG. It has been produced with the latest new technology and offers extensive entertainment and great versatility. We wish you many hours of new great experiences exploring the Android world!

1.1. Safety Instructions

Read all of the instructions before operating the device. Keep these instructions well for later use.

Only use attachments/accessories specified or provided by the manufacturer (such as the exclusive supply adapter, battery etc.). Please refer to the information on the product enclosure for electrical and safety information before installing or operating the apparatus.

To reduce the risk of fire or electric shock, do not expose this apparatus to rain or moisture.

The ventilation should not be impeded by covering the ventilation openings with items, such as newspaper, table-cloths, curtains, etc. The apparatus shall not be exposed to dripping or splashing and no objects filled with liquids, such as vases, shall be placed on the apparatus.

⚠ This mark indicates a risk of electric shock.

To prevent injury, this apparatus must be securely attached to the floor/wall in accordance with the installation instructions.

Danger of explosion if the battery is incorrectly replaced. Replace only with the same or equivalent types.

The battery (battery or batteries or battery pack) shall not be exposed to excessive heat such as sunshine, fire or the like.

Excessive sound pressure from earphones and headphones can cause hearing loss.

Listening to music at high volume levels and for extended durations can damage one's hearing.

In order to reduce the risk of damage to hearing, one should lower the volume to a safe, comfortable level, and reduce the amount of time listening at high levels.

The mains plug or appliance coupler is used as disconnect device, it shall remain readily operable. When not in use and during movement, please take care of the power cord set, e.g. tie up the power cord set with cable tie or something like that. It shall be free from sharp edges or similar which can cause abrasion of the power cord set. When put into use again, please make sure the power cord is not damaged. The absence of a light indication on the apparatus does not mean that it is fully disconnected from the mains. To disconnect the apparatus completely, the mains plug must be pulled out.

Attention should be drawn to environmental aspects of battery disposal.

No naked flame sources, such as lighted candles, should be placed on the apparatus.

🕸 To prevent the spread of fire, keep candles or other open flames away from this product at all times.

Equipment with this symbol is a Class II or double insulated electrical appliance. It has been designed in such a way that it does not require a safety connection to electrical earth.

Precautions

Never try to open the device. It is dangerous to touch the inside of the device due to high voltages and possible electrical hazards. Opening the device will void the warranty of the product. Refer all maintenance or servicing to suitably qualified personnel.

When you are connecting cables, be sure that the device is disconnected from the mains supply voltage. Wait a few seconds after switching off the device before you move the device or disconnect any equipment.

It is a necessity that you only use an approved extension and compatible wiring that is suitable for the electrical power consumption of the installed equipment. Please ensure that the electrical power supply corresponds with the voltage on the electrical identification plate at the back of the device.

⚠ Risk of explosion if the battery is replaced by an incorrect type.

Disposing of a battery into the fire or a hot oven, or mechanically crushing or cutting a battery can result in an explosion.

Leaving a battery in an extremely high temperature surrounding environment can result in an explosion or the leakage of flammable liquid or gas.

A battery subjected to extremely low air pressure may result in an explosion or the leakage of flammable liquid or gas.

Operating Environment

- Do not install this equipment in a confined space such as a bookcase or similar unit.
- Do not use the set near damp, and cold areas, protect the set from overheating.
- Keep away from direct sunlight.
- Do not use the set near dust place.
- Do not place candles near the opening area, to avoid flammable foreign material from entering the device.

WEEE Directive

 Correct Disposal of this product. This marking indicates that this product should not be disposed with other household wastes throughout the EU. To prevent possible harm to the environment or human health from uncontrolled waste disposal, recycle it responsibly to promote the sustainable reuse of material resources. To return your used device, please use the return and collection systems or contact the retailer where the product was purchased. They can take this product for environmental safe recycling.

1.2. Storage

Your device has been carefully checked and packed before shipping. When unpacking it, make sure that all the parts are included and keep the packaging away from children. We recommend that you keep the carton during the warranty period, to keep your device perfectly protected in the event of repair or warranty.

Equipment Set-up

Please follow the instructions below:

This user manual provides complete instructions for installing and using this product. The symbols will serve as follows:

- WARNING:** Indicates warning information.
- NOTE:** Indicates any other additional important or helpful information.
- MENU** Represents a button on the remote control or the product.
- Move to* Represents a menu item within a window.

1.3. Package content

- 1x Google TV Box
- 1x Voice Enabled Remote
- 1x Power USB Adaptor 12V / 1A
- 2x AAA Batteries
- 1x Installation instructions
- 1x HDMI cable version 2.1

WARNING: The batteries should not be recharged, disassembled, electrically short-circuited, be mixed or used with other types of batteries. If rechargeable accumulators instead of batteries are going to be used (e.g. NiMH), we recommend using types with low self-discharge to ensure long time operation of your remote control.

2. TV BOX PANELS

2.1 Front Panel



Fig. 1

On/Off Indicator: Green : Box On / Red : Box on Standby

2.2 Side Panel

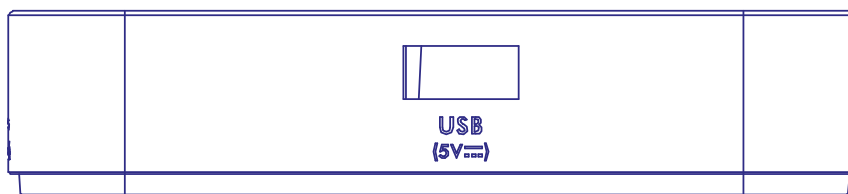
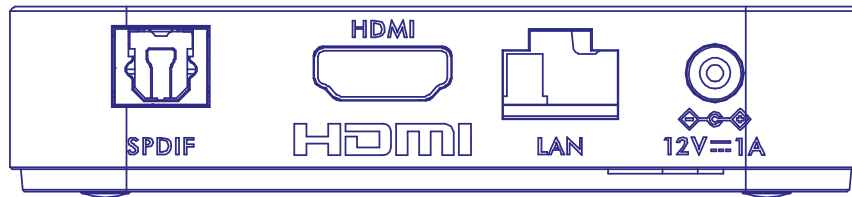

Fig. 2

USB Port

2.3 Rear Panel

Fig. 3



- | | |
|------------------------|--|
| 1. S/PDIF (optical) | To connect to a digital or home cinema audio amplifier. |
| 2. HDMI | To connect your receiver with your TV set or Dolby Digital amplifier using a HDMI cable. |
| 3. LAN / ETHERNET RJ45 | Connect to your Internet router to access the internet/apps. |
| 4. 12 V Adapter entree | To connect the original included 12Volt power adaptor of 1 Ampere. |

2.4 Remote control

- | | |
|-----------------|---|
| 1. | Press to turn the TV/ Box to On, Standby or deep Standby. |
| 2. | Select TV inputs after setup remote button configuration |
| 3. | Call account menu to select between accounts |
| 4. | Press to activate the voice control function*. |
| 5. | Direct access to settings menu. |
| 6. | Navigate the menu. Confirm the selection. |
| 7. | Press to Exit. In menu: step back to previous menu. |
| 8. | Enter the home desktop. |
| 9. | Press to access the TV settings. |
| 10. VOL +/- | Adjust the volume up or down. |
| 11. | Press to mute or restore the volume. |
| 12. | Change programmes up or down. |
| 13. YouTube | Press for direct access to YouTube. |
| 14. NETFLIX | Press for direct access to Netflix** |
| 15. prime video | Press for direct access to prime video***. |
| 16. Disney+ | Press for direct access to Disney+****. |

*Voice control and some other functions could work only when this RCU paired with your TV.

** Membership is not included. Netflix is available in selected countries. Streaming Netflix requires to set up an account. Broadband Internet required. See www.netflix.com/TermsOfUse for details.

*** Membership is not included. Prime is available in selected countries. Streaming prime video requires to set up an account. Broadband Internet required. See www.primevideo.com for details.

**** Membership is not included. Disney+ is available in selected countries. Streaming Disney+ requires to set up an account. Broadband Internet required. See www.disneyplus.com for details.

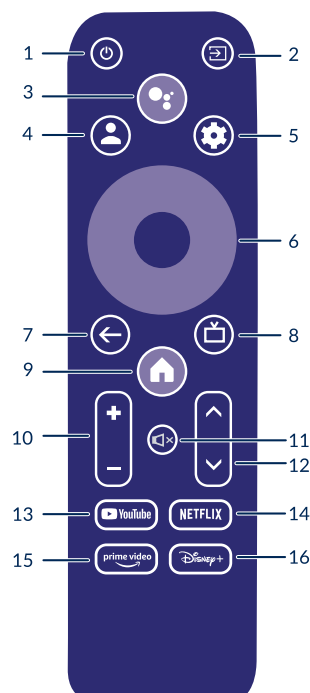

2.5 Installing the batteries

Fig. 4

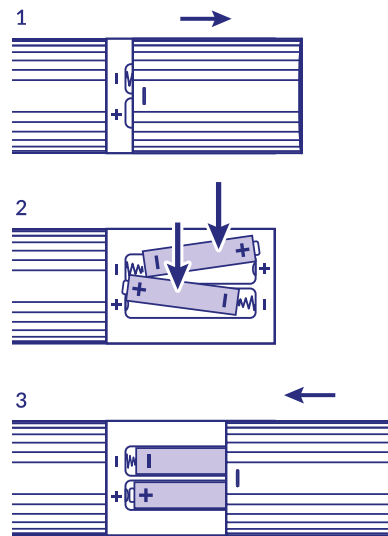

Open the cover on the remote control and insert 2x AAA batteries into the compartment. The correct position of batteries polar diagram is shown inside the batteries compartment.

1. Open the cover.
2. Insert the batteries.
3. Close the lid.

WARNING: The batteries should not be recharged, disassembled, electrically short-circuited, be mixed or used with other types of batteries.

3. CONNECTION GUIDE

Refer to the diagram below for connecting your Google TV Box to the HDMI input of TV.

NOTE: Before getting started, please turn off all devices to be connected.

Fig. 5

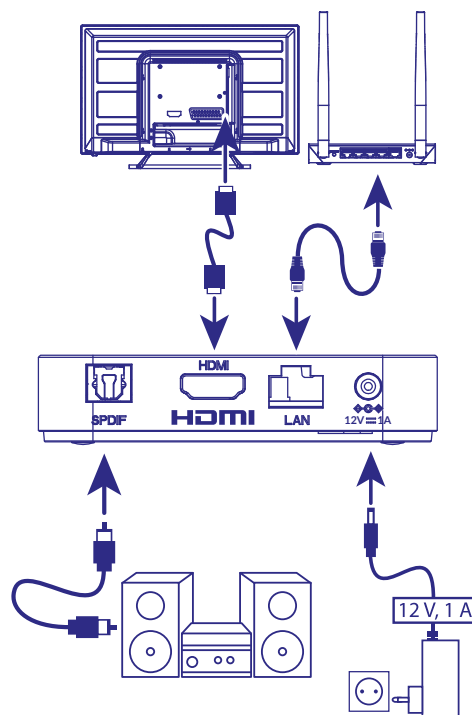

NOTE: The LEAP-S3 box also supports Wi-Fi 2.4GHz and 5GHz. To connect, go to Settings - Network.

- Connect the LEAP-S3 box to your television via the HDMI Cable. Advice: use (the included) type 2.1 as this is supporting UHD, HDR, Dolby Vision resolutions
- Using an Ethernet Cable, connect the LAN Port of the TV Box to the LAN Port of your router or home broadband network.
- Connect the TV Box to power using the power adapter provided. You can then power on your device and begin.

NOTE: Before turning on your device, please switch the signal input of the TV to the correct source

4. SETTING UP YOUR DEVICE

You may turn on your TV Box after properly connecting all hardware.

To be able to use Google Assistant on your remote, you must first pair your Bluetooth Remote to your TV Box for 5 seconds. Follow the pairing instruction on the screen.

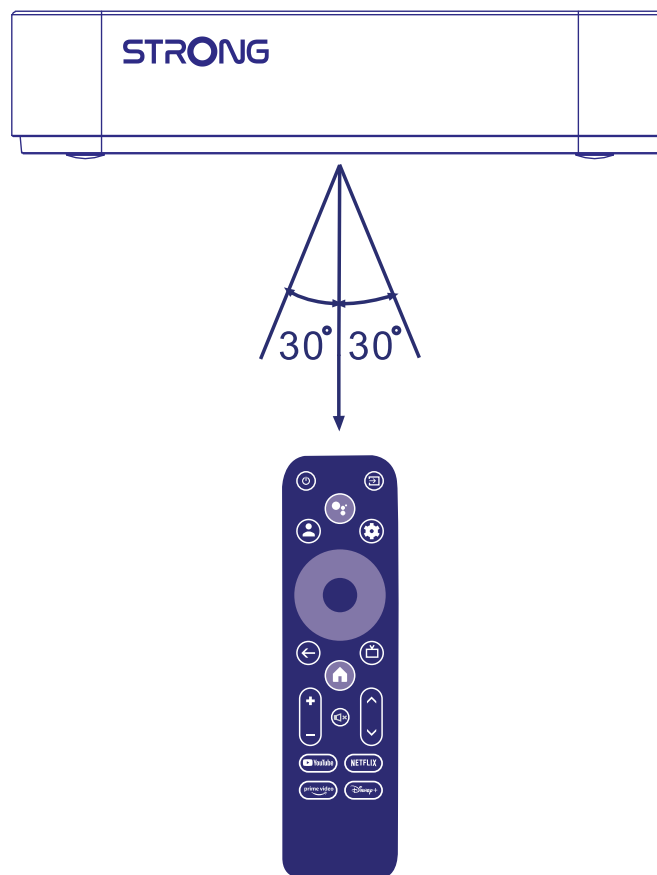

To be able to use Google Assistant on your remote, please pair the remote to your TV Box. Press BACK and HOME together for 5 seconds. The LED will start blinking.

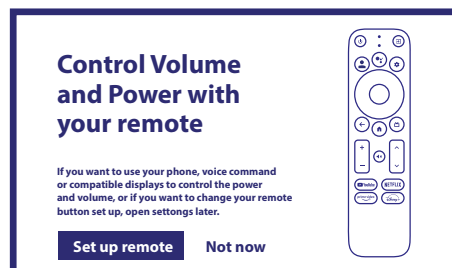

Step 1: Language

Select your preferred language on the Welcome Page.

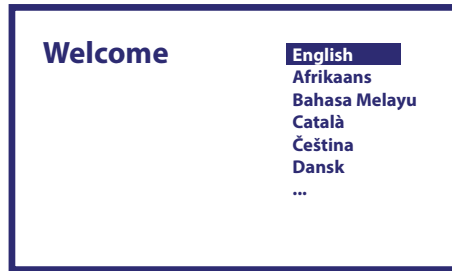

Step 2: Location Settings

Select the region or country where you are using this Google TV Box.



Step 3: Set up with the Google Home App

Set up the TV Box by downloading / opening the Google Home app on your phone. Please, scan the QR code on your phone and follow the instruction to start this Google home. Alternative, Start the set up on TV screen to type manually way by pressing down button to start with. Please, follow the instruction on your TV screen.

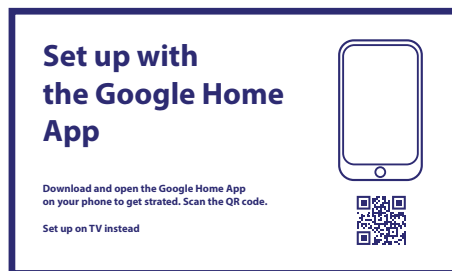

Step 4: Wi-Fi

If you not are connected with RJ45 cable to internet will Wi-Fi setup appear. Select here to your Wi-Fi Network.



Step 5: Google Account

Sign in with your Google Account and Password.

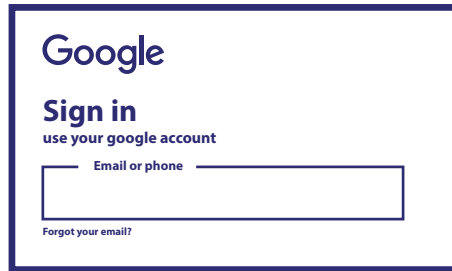

Step 6: Terms of Service & Privacy Policy

Read and accept the Terms of Services & Privacy Policy.

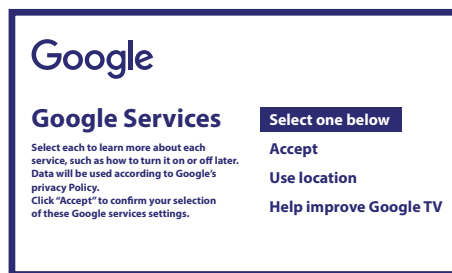

Step 7: Diagnostic Report Settings

Select whether to allow your TV Box to send automatic diagnostic and usage data to Google.

Step 8: Meet your Google Assistant

Turn on the Google Assistant function for the functionality to work on your remote.
Turn on or reject personal results or recommendations.

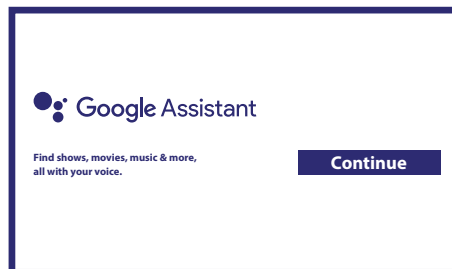

Step 9: Choose your subscriptions

Select or de-select advised application which will automatically installed .
Some apps are forced and cannot de-selected.
Select *Confirm* to proceed

Step 10: Setup remote buttons

If you like to setup some button functions from the connected device as TV, Source, Volume.
Please, follow the instructions on screen. Select Continu to skip this setup.
Afterwards when have more time you can reach this setup again trough settings menu.

Step 11: Welcome to Google TV

A walkthrough of the features of your device



Click on DONE after the walkthrough to start using your device. You are now ready to begin

5. SETTINGS

Press the setting button to open Settings

Select Settings to check the device information, add/remove accounts and make changes to the system settings.

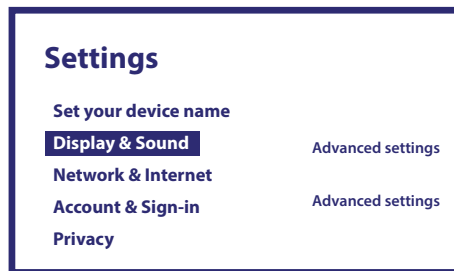

Display and sound

Select HDMI-CEC for setup connections and adjustments through CEC (Consumer Electronics Control).

Select Display settings for selection of screen formats and resolutions.

Select Sounds settings for setup of Dolby and audio formats.

Network and Internet

Under Network Settings, select and enable Wi-Fi in order to connect to the network.

Once the device scans and lists nearby Wi-Fi networks, select the appropriate network name, if required put in the password and select Connect.

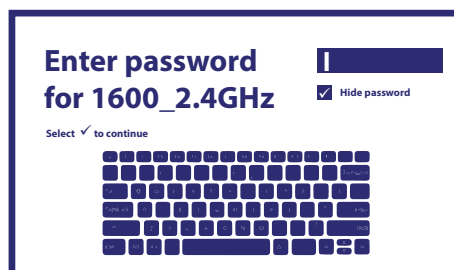

Adding Accounts

For new Google users: sign up for a new Google account using the TV for easier login and payment security. Add an account or switch accounts under Accounts in the Settings Menu.

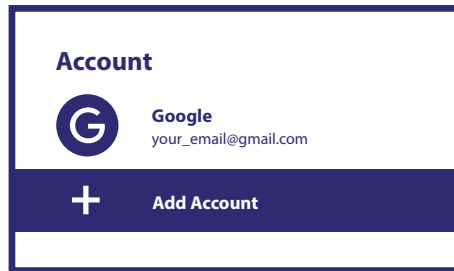

Apps

Select to see permissions access, versions of applications and to remove apps from you TV box.

Bluetooth Pairing

Select Settings in the Menu Launcher, click Remote & Accessories, then select the device to be paired. Make sure that the device you want to pair is in pairing mode. In this menu you can setup some remote buttons to control Volume, Power, Input sources on TV or Digital Home amplifiers.

Remove a Bluetooth Device

Select Settings from the Menu Launcher.

From the Remote & Accessories menu, select the Bluetooth device you want to remove.

Click "Forget" to remove this device.

Language Settings

Under Settings > System > select Language to change the language previously set.

About

You can check information about your device by clicking on ABOUT in the Settings Menu. This panel will show you the model of your device, version, firmware version and more. You can also update your system by clicking on System update from this menu.

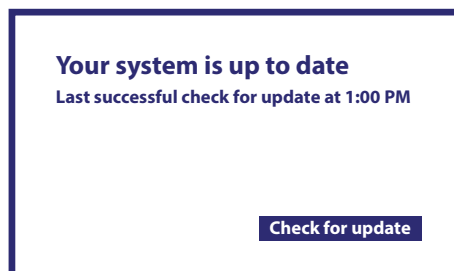

Factory Reset

Under Settings, System > About > Reset

Click Factory data reset to erase everything.

Once this option has been selected, all manually installed apps and user data information will be deleted.

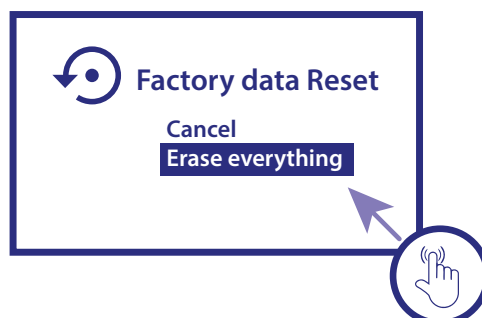

6. DOWNLOADING APPS

Apps are available for download on the Google Play Store. Select "Search" and type name or press microphone and tell name.

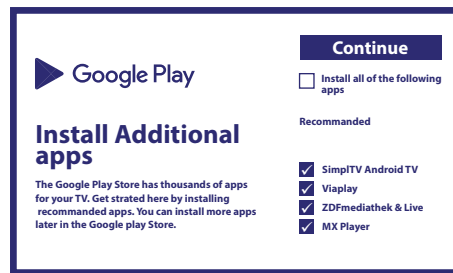

7. GOOGLE CAST

Cast from a Mobile Device

Certain apps allow you to cast to your TV. To cast, simply follow the following steps:

Open a Google cast compatible app on your mobile device

Navigate to the screen you wish to cast

Cast from Google Chrome

This device has Google Chromecast built-in. To cast from Google Chrome, click the Settings icon : located on the top right corner of the browser, then click "Cast".

8. GOOGLE ASSISTANT

Say it to Play it.

Ask it to play your favorite show, video, or music. Or find the latest blockbuster to enjoy.

Movies & TV shows:

Play Stranger Things on Netflix. Video clips: Play cat videos. Apps: Open YouTube. Search: Search for sitcoms.

Info: Tell me about Game of Thrones.

Control

Playback: Pause. Stop. Resume Volume: Louder. Softer. Power: Turn off.

Play music, news, or podcasts

Music: Play music by Sia. (Learn how to choose your music service provider.) News: Play the news. What's the latest news from BBC?

Ask Google

Sports: How did the Patriots do? When is the next Warriors game? Calculations: What's 20% of 80? Dictionary: What does "ludic" mean?

Find answers: How far away is the moon? How do you remove stains in a rug? Unit conversions: How many teaspoons in a cup?



Speak into the microphone of your Voice Search remote.

Learn more about the Google Assistant on assistant.google.com or say "What can you do?" Just ask question like: "How is the weather in Paris?"

To get started, press the Google Assistant button on your remote.

NOTE: To be able to use Google Assistant on your remote, must remote be paired to you TV Box.

9. SIMPLE TROUBLESHOOTING

Issue	Possible Reason	Solution
No LED after power on	The power adapter is not properly connected.	Make Sure the device is connected to the power.
No Sound	<ul style="list-style-type: none"> The Tv is on Mute or volume is low. The device is on Mute or the volume is too low. 	Press the mute button to restore the sound and increase the volume.
Failed to connect to network	Wi-Fi is turned off or the signal is too weak.	Restart the Wi-Fi or adjust the position of the device closer to the router.
Remote Control Failure	<ul style="list-style-type: none"> Remote control batteries are low in power. Lost pairing 	Replace batteries. Switch main power OFF/ON and pair remote with BACK & HOME button press 5 seconds. Wait until pair screen appears, pair.
No Picture on Screen	Wrong TV HDMI input. Not use High resolution HDMI cable V2.1	Make sure that correct HDMI is selected as your TV input. Check if you not are using old HDMI cable.
Voice search on remote is not working	Remote is not paired to the Google TV Box	See the Pairing Bluetooth Device section in this guide
No Audio	Audio Settings not configured correctly for your TV	Settings> Display & Sound > Advanced sound settings

10. TECHNICAL SPECIFICATIONS

Video decoder

Video resolution: 4Kp60, 1080p60, AV1, VP8/VP9, HEVC H.265, AVC H.264, MPEG-4,MP@ML, MP@HL profiles, Dolby Vision, HDR10+, HDR10, HLG

Audio decoder

Audio decoding: 32KHz to 192KHz sample rates, Dolby Digital* MS12, Dolby* ATMOS, AAC LC, AAC LC + SBR Level 2, AAC 5.1, HE AAC Level 2 & Level 4, MPEG Audio Layers 1, 2 &3, MPEG-4 Audio

* Dolby, Dolby Audio, and the double-D symbol are trademarks of Dolby Laboratories Licensing Corporation.

System & Memory

Android Version: 11
Chipset: Amlogic S905Y4
CPU: Amlogic S905Y4 Quad Core Cortex-A35, 2.0 GHz
GPU: ARM G31 MP2 OpenGL ES 3.2 Graphics engine
SDRAM: LPDDR RAM: 2 GB
Flash: eMMC: 16 GB

Connectors

HDMI: Version 2.1
Ethernet: RJ 45, 10/100
1x USB 2.0: Type A, 500mA
S/PDIF: Optical
DC IN: 12 V,1 A

General data

Wi-Fi: IEEE 802.11b/g/n, 2.4 GHz
IEEE 802.11a/n/ac, 5 GHz
Bluetooth: 5.0 (LE 4.2)
Power supply: 100 - 240 V AC, 50/60 Hz
Input voltage: DC 12 V, 1 A
Power consumption working: 7 W (max.)
Operating temperature range: 0 ~ +40 °C
Storage temperature: -10 ~ +70 °C
Dimensions (W x D x H) in mm: 96 x 96 x 20,8
Weight: 179 g

Data Protection:

Please be aware that STRONG, its manufacturing partners, the application providers and the providers of the services may collect and use technical data and related information, including but not limited to technical information about this device, system and application software and peripherals. STRONG, its manufacturing partners, the application providers and the providers of the services may use such information to improve its products or to provide services or technologies to you, as long as it is in a form that does not personally identify you.

Additionally, please keep in mind that some services provided - already in the device or installed by you - may request a registration for which you have to provide personal data.

Beside that, please be aware that some services which are not pre-installed but can be installed may collect personal data even without providing additional warnings and that STRONG cannot be held liable for a possible breach of data protection by services not pre-installed.

* Availability of apps depending on the country. STRONG cannot be held liable for services by third parties. Offers by third parties may be changed or removed at any time, may not be available in all regions and may require a separate subscription.

