



# **REVOLUTION D.F.X**

## **1350W / 1650W**

**REVOLUTION D.F.X**

- ATX 3.0 & PCIe 5.0 Ready
- Fully Modular 80 PLUS® GOLD Certified
- Attached Native 600mm 12VHPWR Cable
- Extra One Dual 8 Pin to 12+4 Pin (12VHPWR) Cable
- 100% Japanese Capacitors
- ARGB Lighting Control Button and M/B Sync
- Dust-free Rotation Tech.
- Semi-fanless Tech. for Absolute Silence under 40% Load

**Features**

- **Awesome User Friendly & Compatibility**
  - Easier cable management with full-modular design
  - Easily connect to PSU and GPU with native 12VHPWR cable, which has the same connector on both sides
  - An extra dual PCIe 8pin to 12VHPWR cable for more flexibility
  - Dust-free Rotation technology enables fan to activate self-cleaning when powering up
- **Silence and Durability**
  - Semi-fanless technology for absolute silence under 40% load
  - Providing better durability with a 12cm industrial-grade dual-ball bearing fan
- **Efficiency & Security**
  - 80 PLUS® GOLD certification delivers up to 92% efficiency at 50% power load
  - 100% Japanese capacitors, which offer stability and reliability to prolong lifespan
  - Multiple protection circuitries of OCP, OVP, UVP, OPP, OTP and SCP that provide a secure experience
  - Half bridge LLC resonant converter & DC to DC circuit design offers higher output efficiency and voltage stability
  - Avoid shutting down from heavy usage with single rail +12V design, and it can be installed simply also
- **RGB function**
  - One button to turn on the RGB lighting effects
  - Built-in 14 smart lighting modes for different performance characteristics
  - Two ways to light it up by M/B sync and built-in button

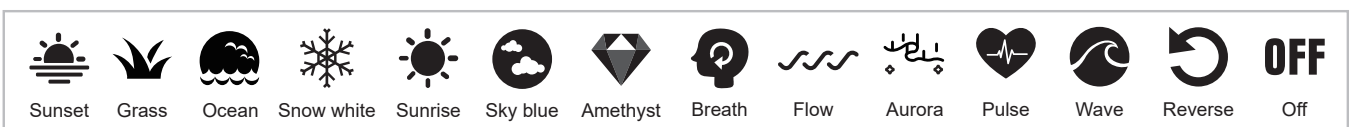

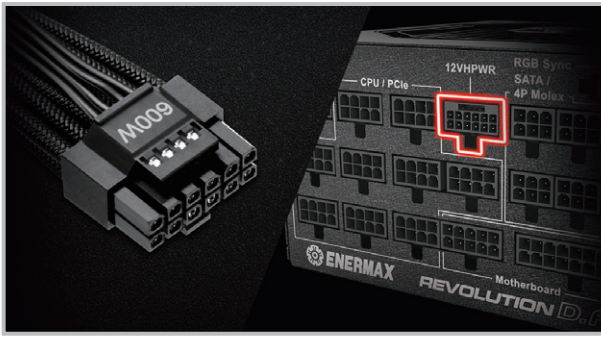

ATX 3.0 & PCIe 5.0 Ready

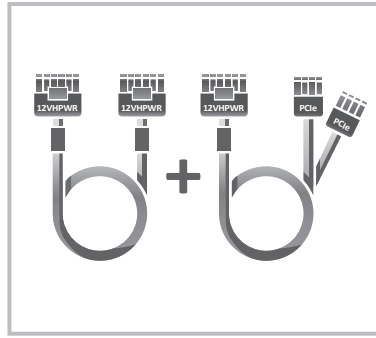

Extra Dual PCIe 8 pin to 12VHPWR Cable



One Button to Turn On / Off RGB Lighting

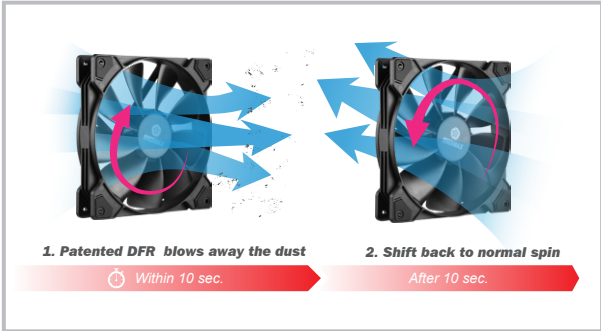

Dust-free Rotation (DFR) Function

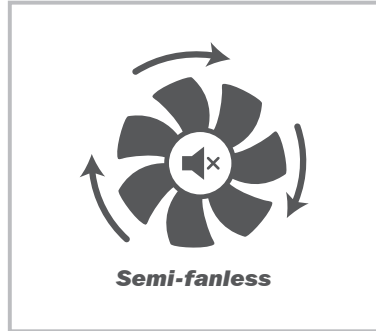

Silent Operation with Semi-fanless Function

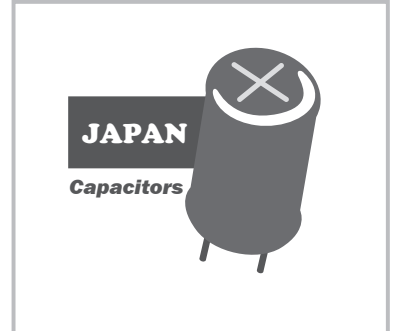

100% Japanese Capacitors

## Dimension

Unit : mm

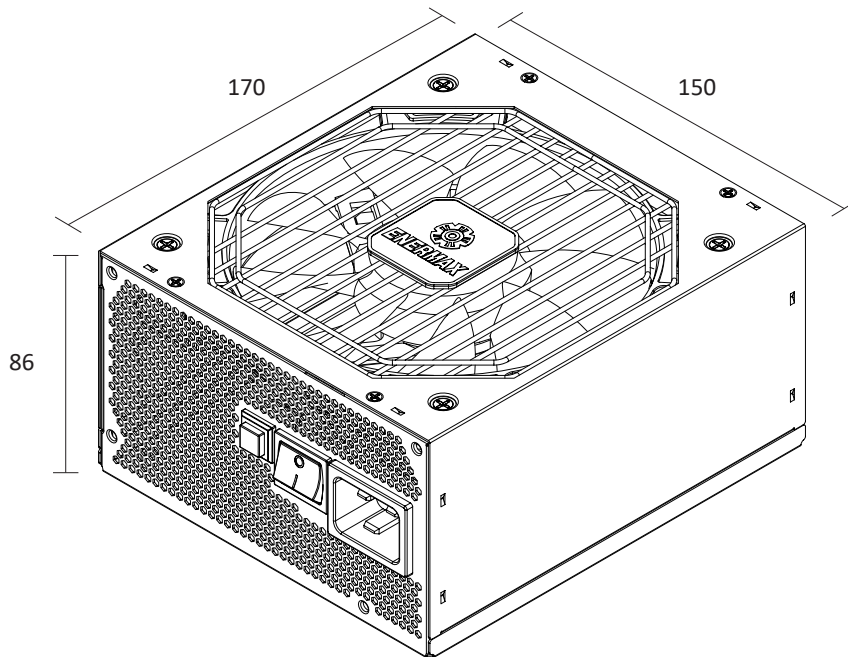

## Cables & Connectors

Product	Modular Cables						
	Mainboard 24P	CPU 4+4P (8P)	12VHPWR(12+4P)	PCIe 6+2P(8P)	SATA	4P Molex	FDD (adapter)
1350W	1	2	2	7	12	6	1
1650W	1	2	3	7	14	7	1

# Specifications

## General Data

80 PLUS EFFICIENCY	GOLD
MODULAR	Fully modular
CABLE TYPE	Individually Sleeved Cable
FAN SIZE (MM)	140
OPERATING TEMPERATURE (°C)	40
MTBF (HOURS)	>100K
PROTECTION	OCP, OVP, UVP, OPP, OTP, SCP

## Power Output

Model Number	ERT1350EWT		ERT1650EWT	
AC Input Voltage	100-240VAC, 50-60Hz		115-240VAC, 50-60Hz	
AC Input Current	15-6.5A		15-8A	
	DC Output			
	Rated	Combined	Rated	Combined
+3.3V	25A	150W	25A	150W
+5V	25A		25A	
+12V	112.5A	1350W	137.5A	1650W
-12V	0.3A	3.6W	0.3A	3.6W
+5Vsb	3A	15W	3A	15W
Total Power	1350W		1650W	
Dimensions	150(W) x 86(H) x 170(D) mm			



## Logistic Information

Model	ERT1350EWT		ERT1650EWT	
Bar code	EAN	4713157727626	4713157727633	
	UPC	819315027622	819315027639	
Box Dimension	360 x 210 x 115 mm			
Gross Weight / Unit	4.08 kg		4.43 kg	
Carton Dimension	485 x 390 x 235 mm			
Q'ty / Carton	4pcs			
Gross Weight / Carton	17.19 kg		18.59 kg	